

DOCUMENT NO.
DL-0045A
0705

MicroSite™
DESIGN PARTNER

SURFACE MOUNT MULTI CHIP MODULE pg 01

IntraGlobal.net
PO Box 500037 Atlanta GA 31150
770 390 0203 www.intraglobal.net

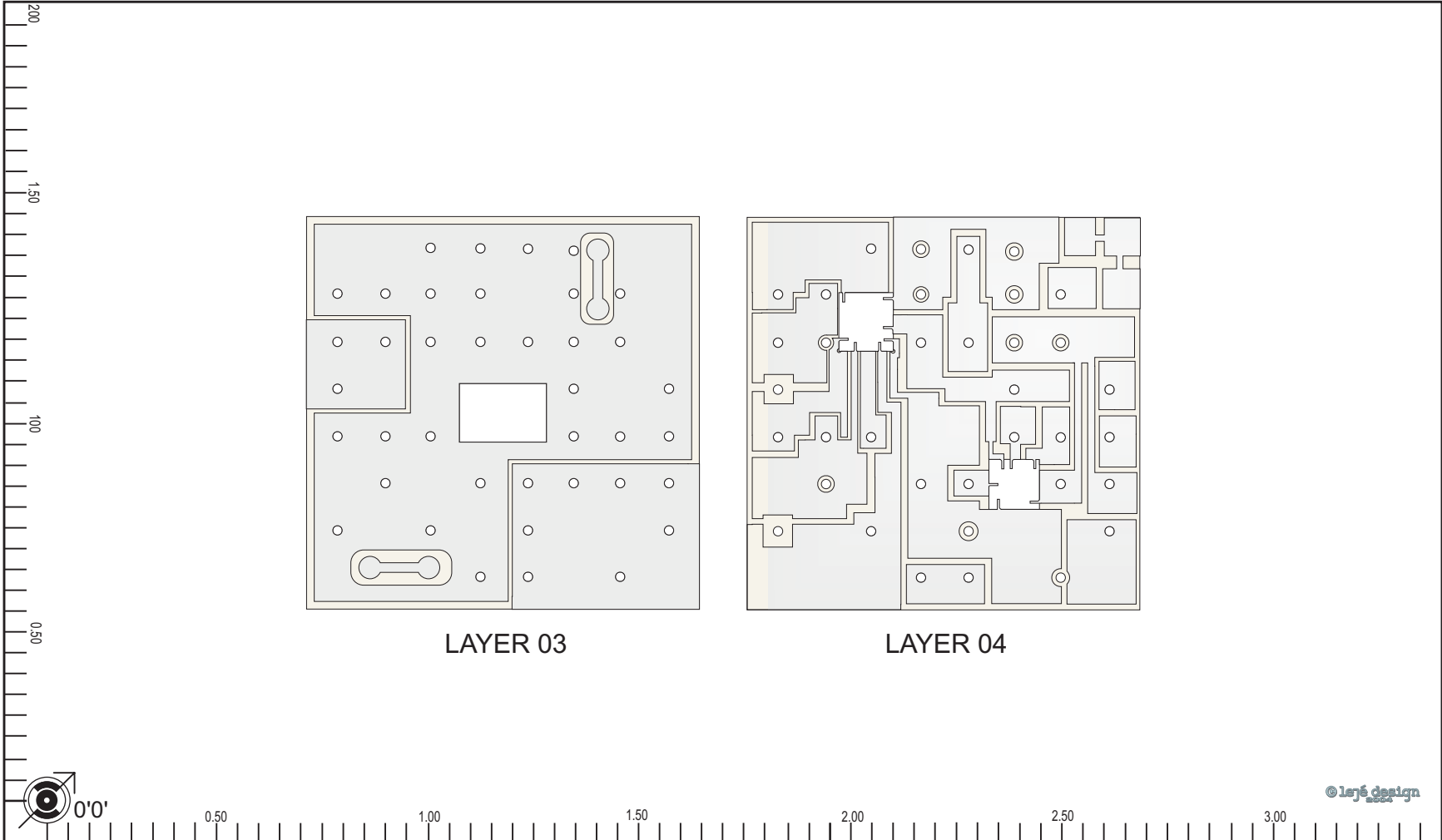

LAYER 03

LAYER 04

© layer design

DOCUMENT NO.
DL-0045B
0705

MicroSite™
DESIGN SOFTWARE

SURFACE MOUNT MULTI CHIP MODULE pg 02

IntraGlobal.net
PO Box 500037 Atlanta GA 31150
770 390 0203 www.intraglobal.net

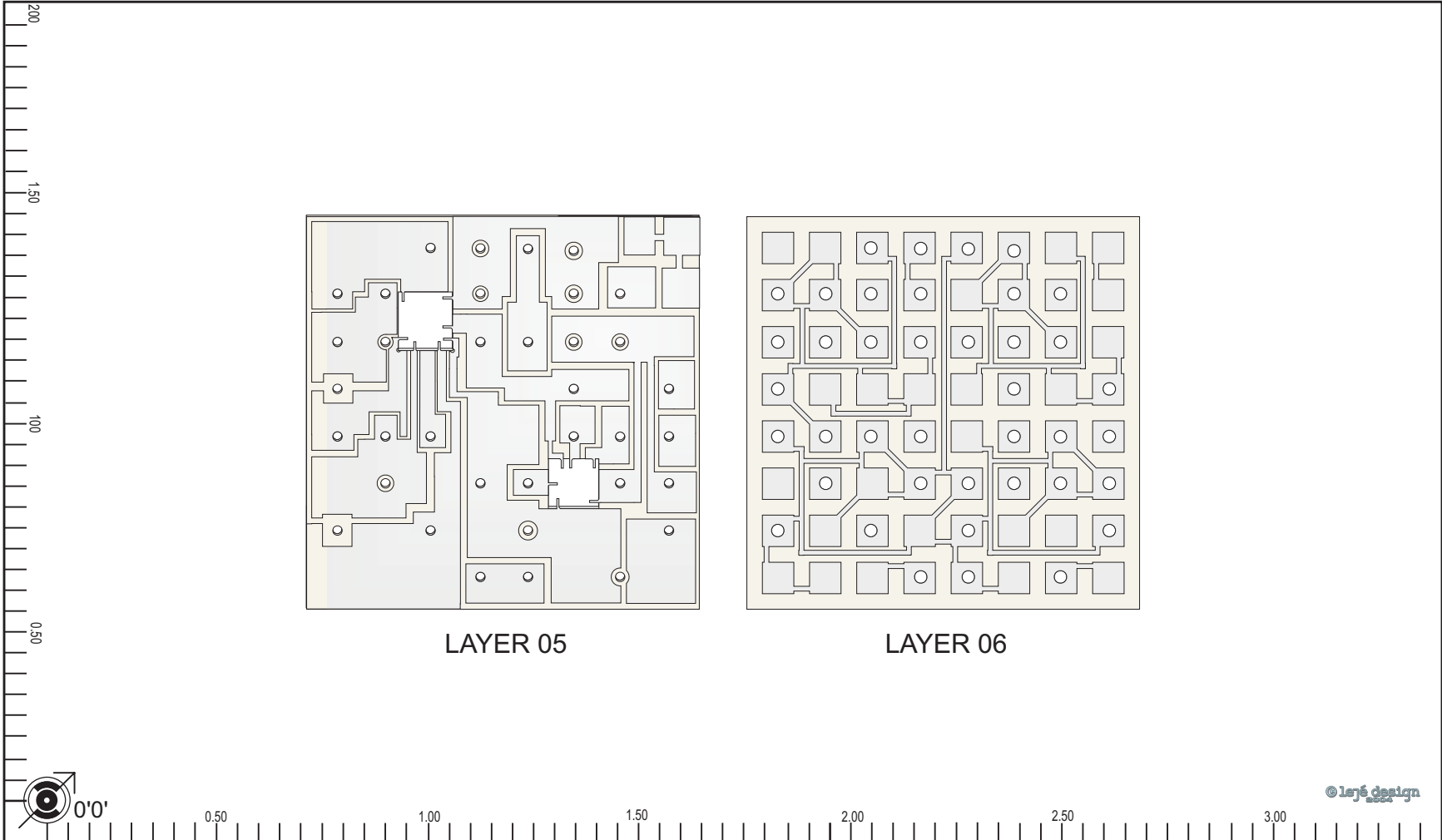

LAYER 05

LAYER 06

© layer design

DOCUMENT NO.
DL-0045C
0705

MicroSite™
DESIGN PARTNER

SURFACE MOUNT MULTI CHIP MODULE pg 03

IntraGlobal.net
PO Box 500037 Atlanta GA 31150
770 390 0203 www.intraglobal.net

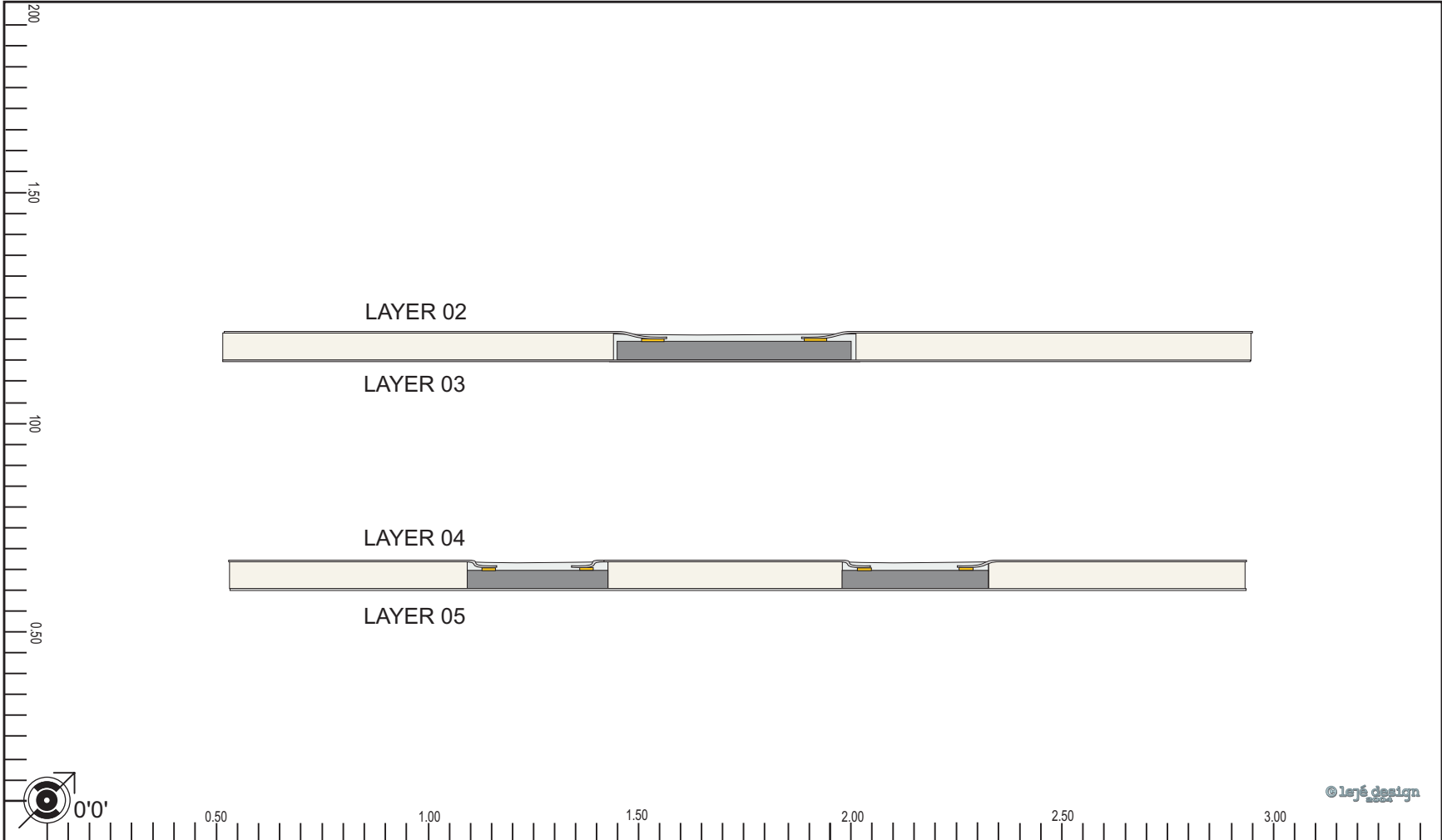

© leyd design

DOCUMENT NO.
DL-0045C
0705

MicroSite™

SURFACE MOUNT MULTI CHIP MODULE pg 04

IntraGlobal.net
PO Box 500037 Atlanta GA 31150
770 390 0203 www.intraglobal.net

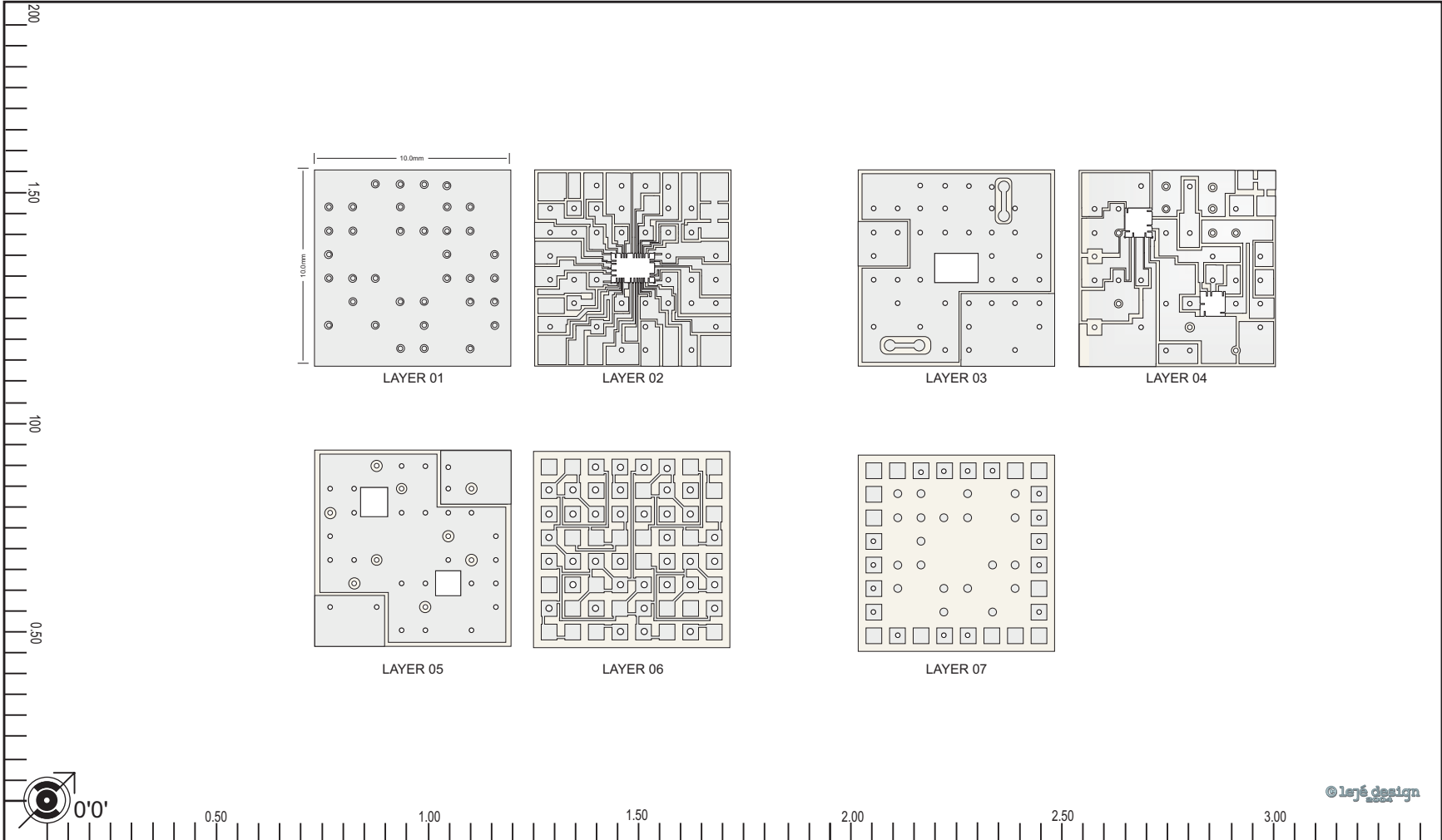

DOCUMENT NO.
DL-0045C
0705

MicroSite[™]
DESIGN PARTNER

SURFACE MOUNT MULTI CHIP MODULE pg 05

IntraGlobal.net
PO Box 500037 Atlanta GA 31150
770 390 0203 www.intraglobal.net

© lrp design

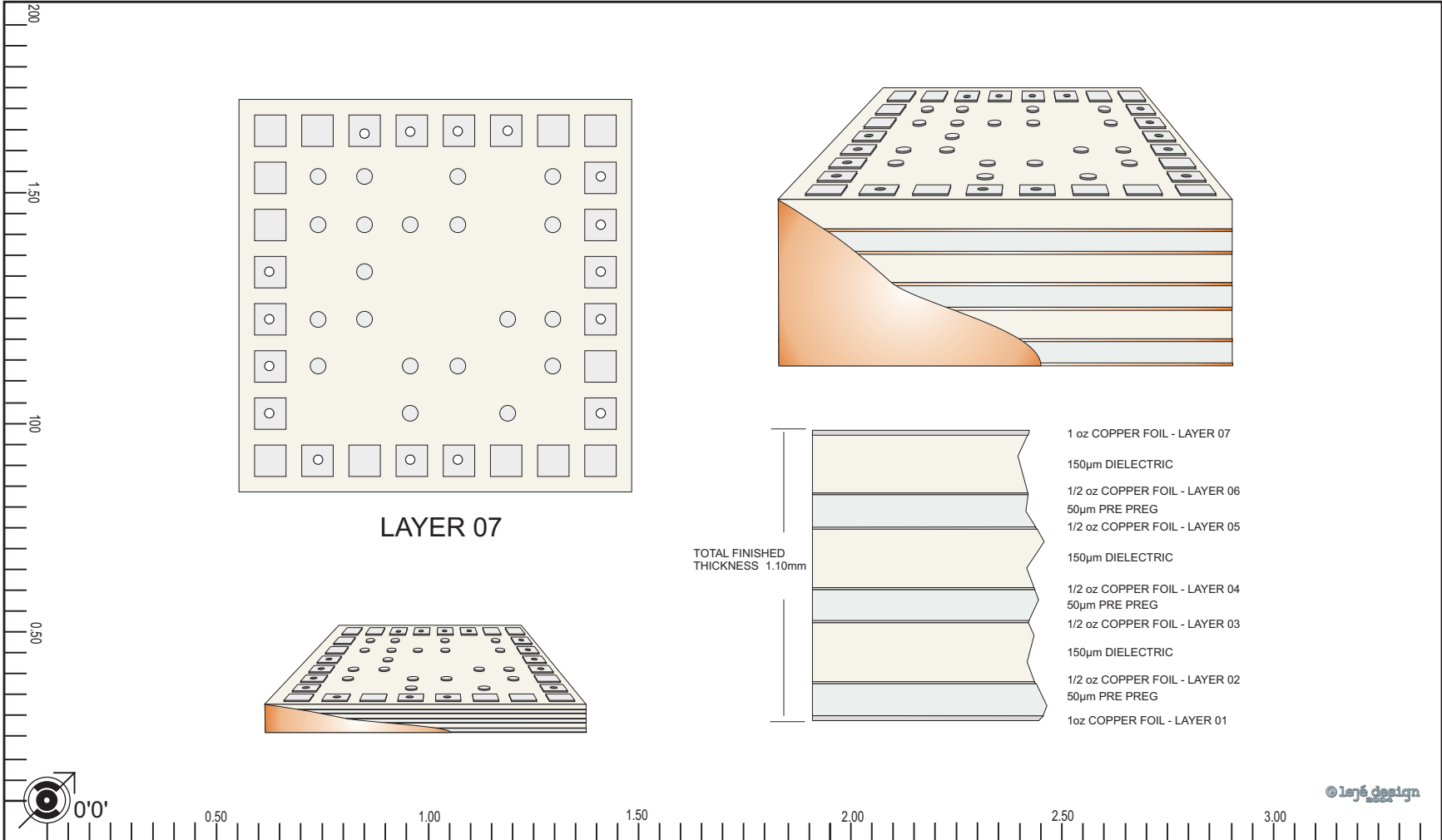

DOCUMENT NO.
DL-0045D
0705

MicroSite™
DESIGN PARTNER

SURFACE MOUNT MULTI CHIP MODULE pg 06

IntraGlobal.net
PO Box 500037 Atlanta GA 31150
770 390 0203 www.intraglobal.net

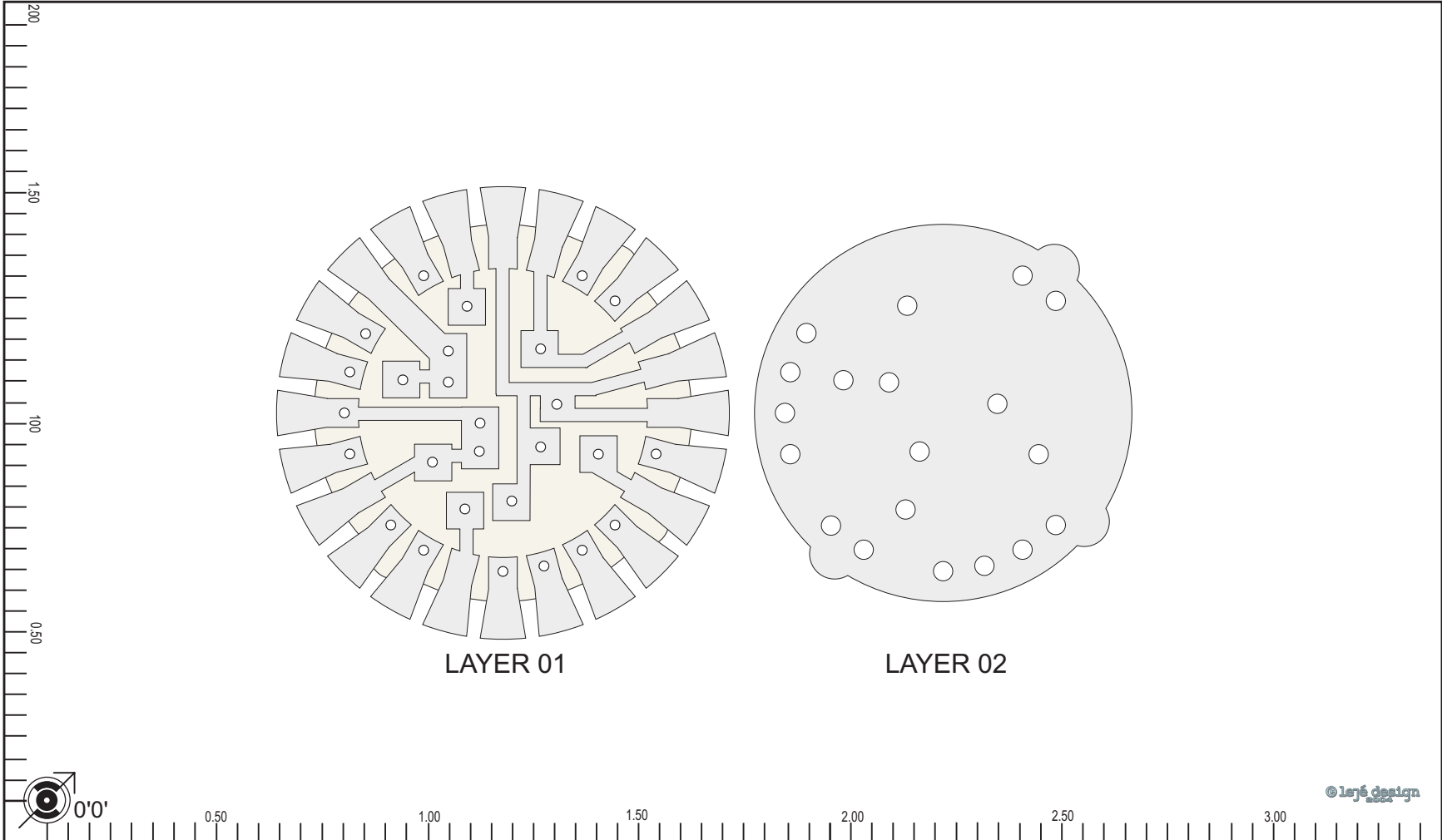

© layer design

DOCUMENT NO.
DL-045E
0705

MICROFLANGE® MULTI CHIP MODULE pg 01

MicroSite™
DESIGN SERVICES

IntraGlobal.net
PO Box 500037 Atlanta GA 31150
770 390 0203 www.intraglobal.net

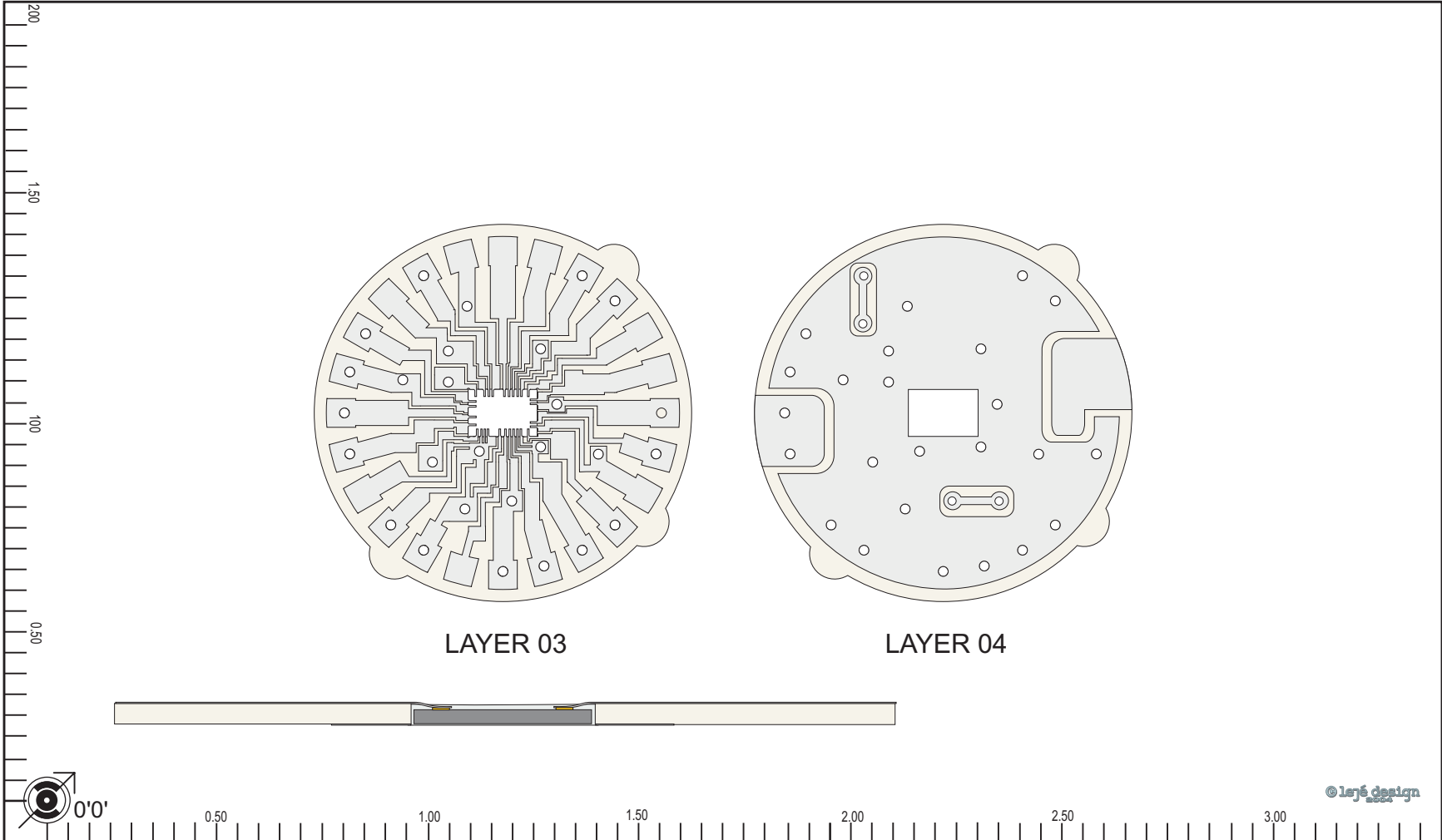

DOCUMENT NO.
DL-45F
0705

MicroSite™
DESIGN PARTNER

MICROFLANGE® MULTI CHIP MODULE pg 02

IntraGlobal.net
PO Box 500037 Atlanta GA 31150
770 390 0203 www.intraglobal.net

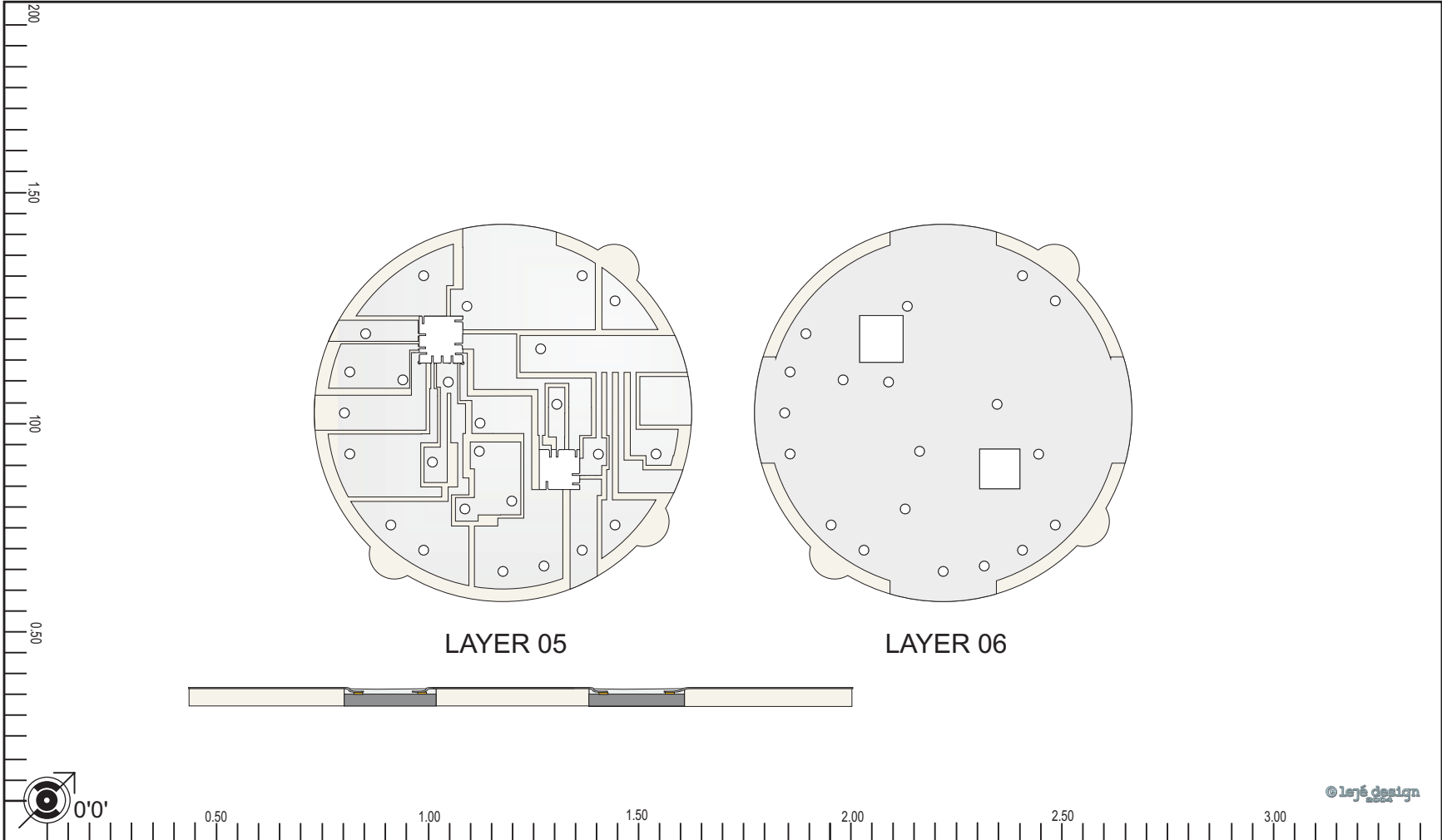

© layer design

DOCUMENT NO.
DL-045G
0705

MICROFLANGE® MULTI CHIP MODULE pg 03
MicroSite™

IntraGlobal.net
PO Box 500037 Atlanta GA 31150
770 390 0203 www.intraglobal.net

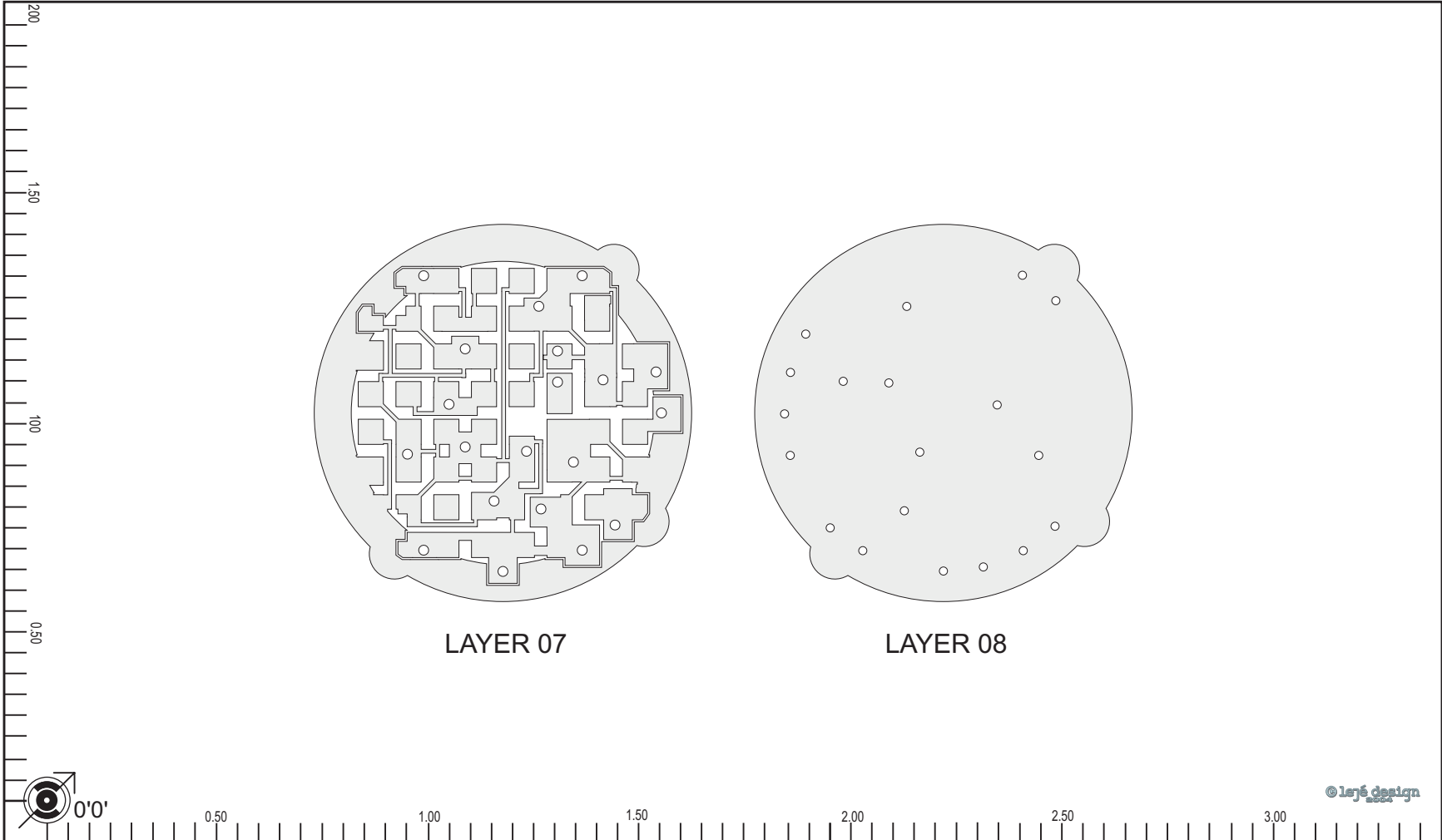

DOCUMENT NO.
DL-045H
0705

MicroSite_®
DESIGN SERVICES

MICROFLANGE[®] MULTI CHIP MODULE pg 04

IntraGlobal.net
PO Box 500037 Atlanta GA 31150
770 390 0203 www.intraglobal.net

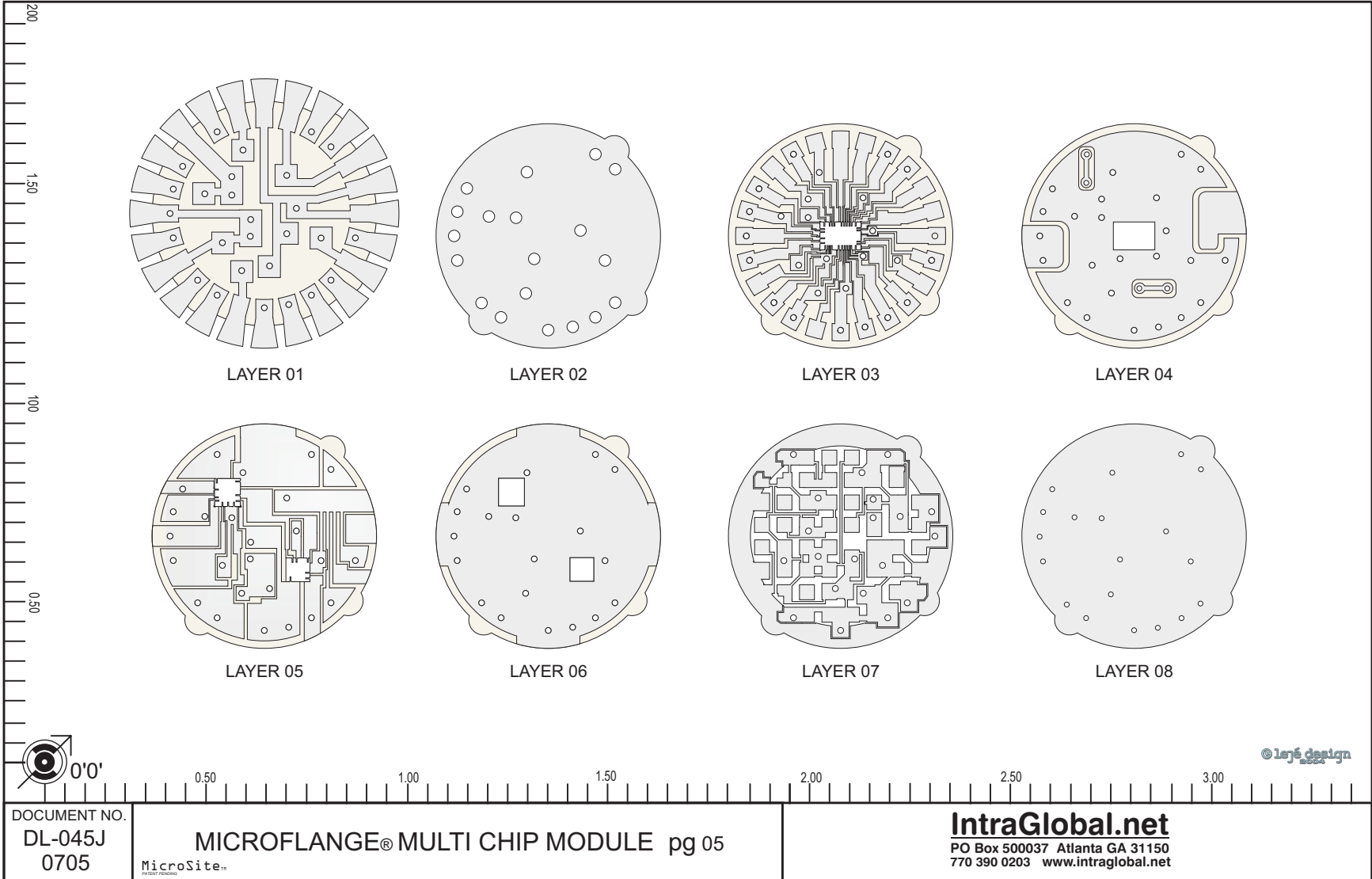

LAYER 01

LAYER 02

LAYER 03

LAYER 04

LAYER 05

LAYER 06

LAYER 07

LAYER 08



© layer design

DOCUMENT NO.
DL-045J
0705

MICROFLANGE® MULTI CHIP MODULE pg 05
MicroSite™

IntraGlobal.net
PO Box 500037 Atlanta GA 31150
770 390 0203 www.intraglobal.net

