

PRELIMINARY SPEC

Part Number: APG1608SURKC/T

Hyper Red

Features

- 1.6mmX0.8mm SMT LED, 0.25mm thickness.
- Low power consumption.
- Wide viewing angle.
- Compatible with automatic placement equipment.
- Ideal for backlight and indicator.
- Package: 2000pcs / reel.
- Moisture sensitivity level : level 3.
- RoHS compliant.

Description

The Hyper Red source color devices are made with Al-GaNp on GaAs substrate Light Emitting Diode.

Applications

- 1.Mobile phone Keypad indicator and backlight.
- 2.Flat backlight for LCD, switch and symbol.
- 3.Toys.

Package Dimensions

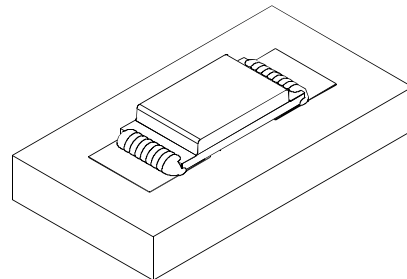
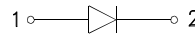
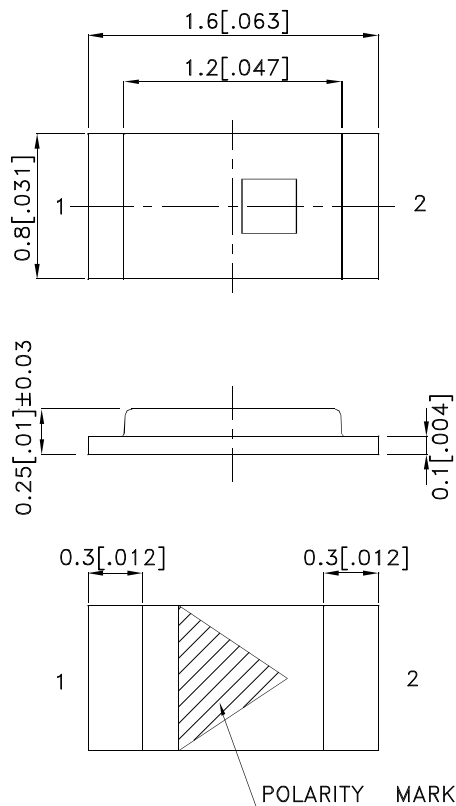

Notes:

1. All dimensions are in millimeters (inches).
2. Tolerance is ±0.1(0.004") unless otherwise noted.
3. Specifications are subject to change without notice.
4. The device has a single mounting surface. The device must be mounted according to the specifications.



Selection Guide

Part No.	Dice	Lens Type	Iv (mcd) [2] @ 20mA		Viewing Angle [1]
			Min.	Typ.	2θ1/2
APG1608SURKC/T	Hyper Red (AlGaInP)	WATER CLEAR	180	320	120°

Notes:

1. θ1/2 is the angle from optical centerline where the luminous intensity is 1/2 the optical centerline value.
2. Luminous intensity/ luminous Flux: +/-15%.

Electrical / Optical Characteristics at TA=25°C

Symbol	Parameter	Device	Typ.	Max.	Units	Test Conditions
λ _{peak}	Peak Wavelength	Hyper Red	650		nm	I _F =20mA
λ _D [1]	Dominant Wavelength	Hyper Red	630		nm	I _F =20mA
Δλ _{1/2}	Spectral Line Half-width	Hyper Red	20		nm	I _F =20mA
C	Capacitance	Hyper Red	35		pF	V _F =0V;f=1MHz
V _F [2]	Forward Voltage	Hyper Red	2	2.5	V	I _F =20mA
I _R	Reverse Current	Hyper Red		10	uA	V _R =5V

Notes:

1. Wavelength: +/-1nm.
2. Forward Voltage: +/-0.1V.

Absolute Maximum Ratings at TA=25°C

Parameter	Hyper Red	Units
Power dissipation	75	mW
DC Forward Current	30	mA
Peak Forward Current [1]	150	mA
Reverse Voltage	5	V
Operating Temperature	-40°C To +85°C	
Storage Temperature	-40°C To +85°C	

Note:

1. 1/10 Duty Cycle, 0.1ms Pulse Width.

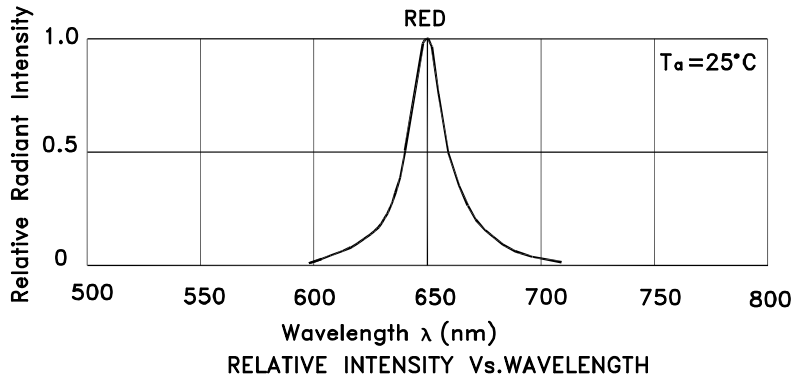

Hyper Red

APG1608SURKC/T

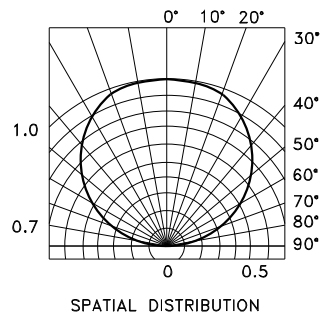
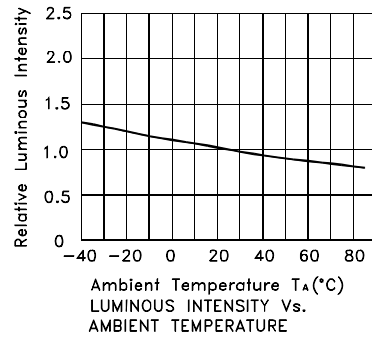
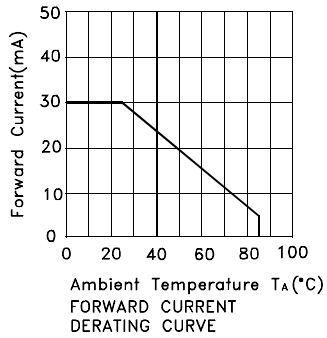
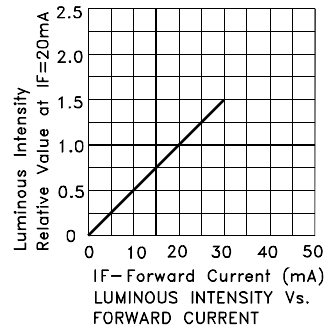
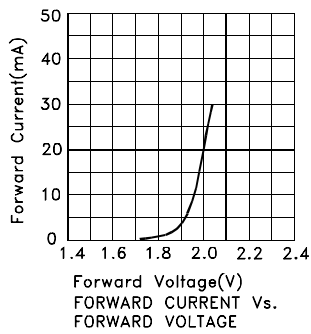

APG1608SURKC/T

Reflow soldering is recommended and the soldering profile is shown below.
Other soldering methods are not recommended as they might cause damage to the product.

Reflow Soldering Profile For Lead-free SMT Process.



NOTES:

1. We recommend the reflow temperature 245°C(+/-5°C). The maximum soldering temperature should be limited to 260°C.
2. Don't cause stress to the epoxy resin while it is exposed to high temperature.
3. Number of reflow process shall be 2 times or less.

Recommended Soldering Pattern (Units : mm; Tolerance: ± 0.1)

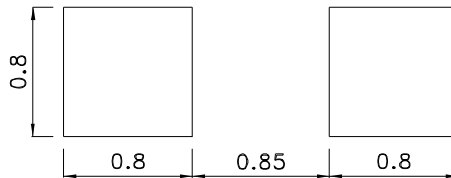

Tape Dimensions (Units : mm)

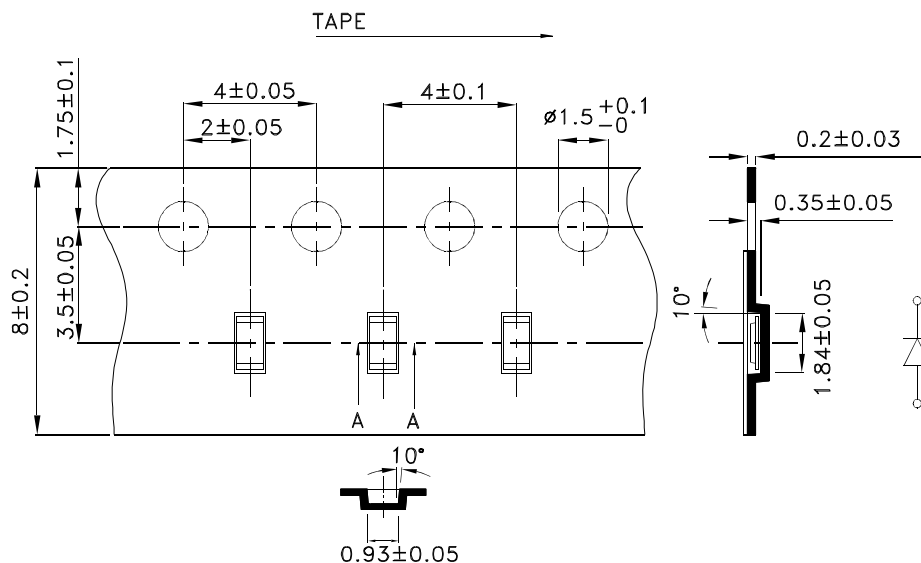

Kingbright

PACKING & LABEL SPECIFICATIONS

APG1608SURKC/T

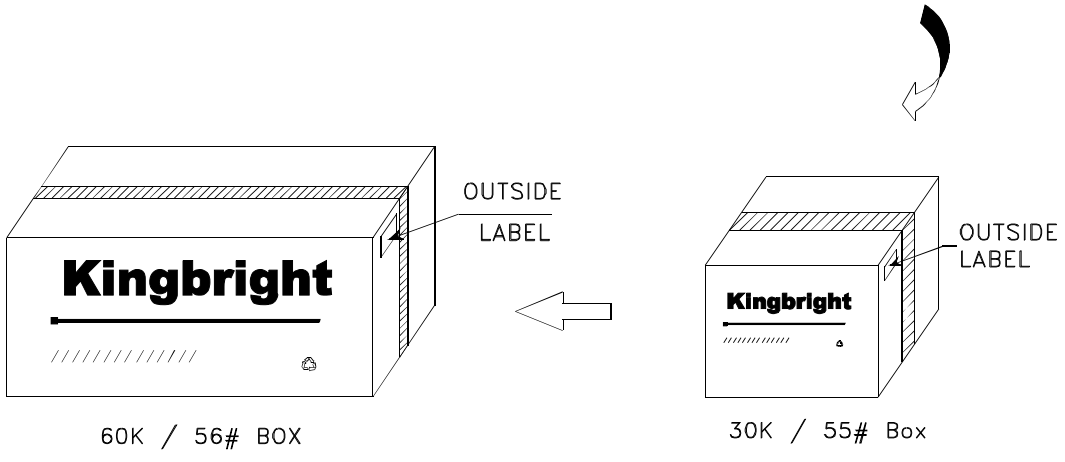
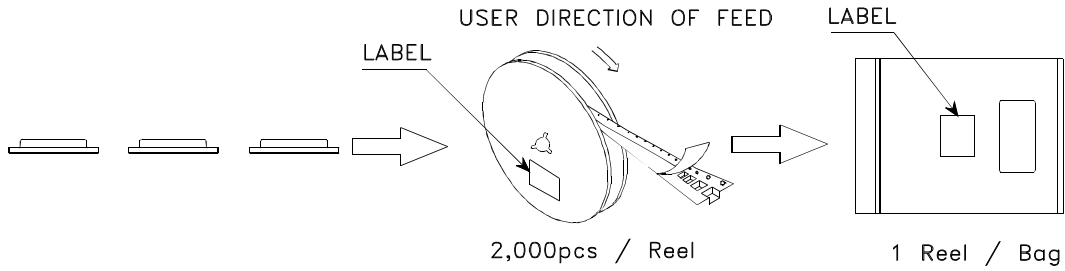

<h1>Kingbright</h1>	
P/NO: APG1608xxx	
QTY: 2,000 pcs	Q.C. Q C XX XX XXXX PASSED
S/N: XXXX	
CODE: XXX	
LOT NO:	
 XXXXXXXXXXXXXXXXXXXXXXXXXXXX	
RoHS Compliant	